

| POLE SHAFT SPECIFICATIONS | | | | |
|----------------------------------|---|--------------------------|------------------|-----------------|
| 1. | SHAFTS ARE ONE SECTION DESIGN FABRICATED FROM 6063 T6 ALUMINUM EXTRUSION. | | | |
| 2. | BASE CASTING IS 356 T6 ALUMINUM. THE SHAFT TELESCOPES INTO THE BASE CASTING AND IS CIRCUMFERENTIALLY WELDED TOP AND BOTTOM. | | | |
| 3. | ANCHOR BOLTS ARE "L" FORMED RODS HAVING A MINIMUM YIELD STRENGTH OF 55,000 P.S.I. FABRICATED FROM ASTM F1554 GR. 55 AND FULLY GALVANIZED PER ASTM 153 SPECIFICATIONS AND FURNISHED COMPLETE WITH 2 HEX NUTS AND 2 FLAT WASHERS. | | | |
| 4. | POLES SHALL HAVE A POLYESTER POWDER COAT FINISH IN A STANDARD COLOR. | | | |
| POLE DIMENSIONS | | | | |
| POLE HGT. (FT.) | TOP DIA. (IN.) | BOTTOM DIA. (IN.) | GAGE | MTG. HGT. (FT.) |
| 14' | 5.00 | 5.00 | .125 | 14' |
| BASE PLATE DIMENSIONS | | | | |
| BOLT CIRCLE (IN.) | BASE PLATE DIM. (IN.) | BOLT HOLE (IN.) | PLATE THK. (IN.) | |
| 7.50-9.00 | 10.75 SQ | .81 | .75 | |
| ANCHOR BOLT DIMENSIONS | | | | |
| ANCHOR BOLT DIA. (IN.) | | ANCHOR BOLT LENGTH (IN.) | | |
| .75 | | 20.00 | | |
| ALLOWABLE WIND LOADING (SQ. FT.) | | | | |
| WIND* | 80 MPH | 90 MPH | 100 MPH | 120 MPH |
| EPA | 8.8 | 6.7 | 4.9 | 3.5 |

*WITH 1.3 GUST FACTOR

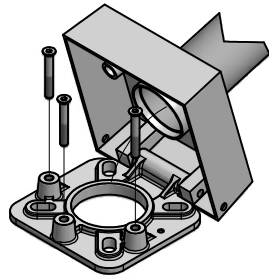

BASE ROTATION DETAIL VIEW

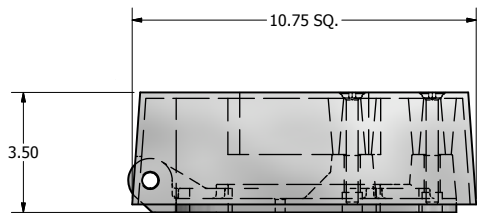
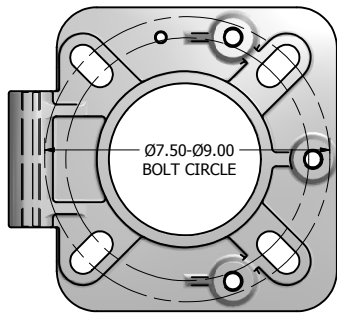

10.75 X 10.75 X 3.50 THK. BASE CASTING

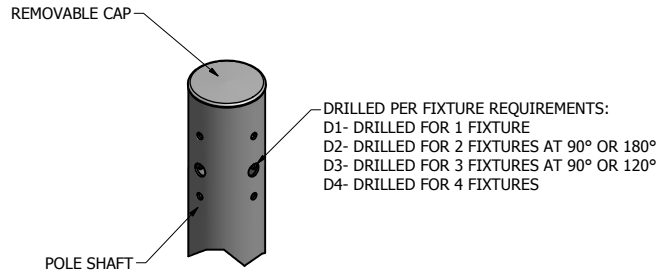

DRILLED MOUNT OPTIONS

DRILLED PER FIXTURE REQUIREMENTS:
 D1- DRILLED FOR 1 FIXTURE
 D2- DRILLED FOR 2 FIXTURES AT 90° OR 180°
 D3- DRILLED FOR 3 FIXTURES AT 90° OR 120°
 D4- DRILLED FOR 4 FIXTURES

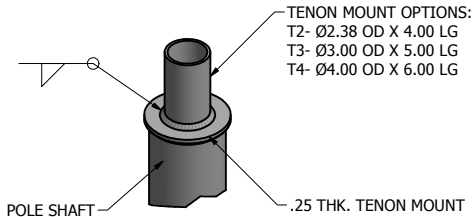

TENON MOUNT OPTIONS

TENON MOUNT OPTIONS:
 T2- Ø2.38 OD X 4.00 LG
 T3- Ø3.00 OD X 5.00 LG
 T4- Ø4.00 OD X 6.00 LG

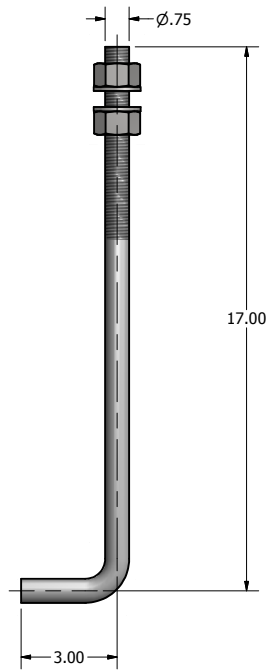

Ø.75 X 20.00 ANCHOR BOLT

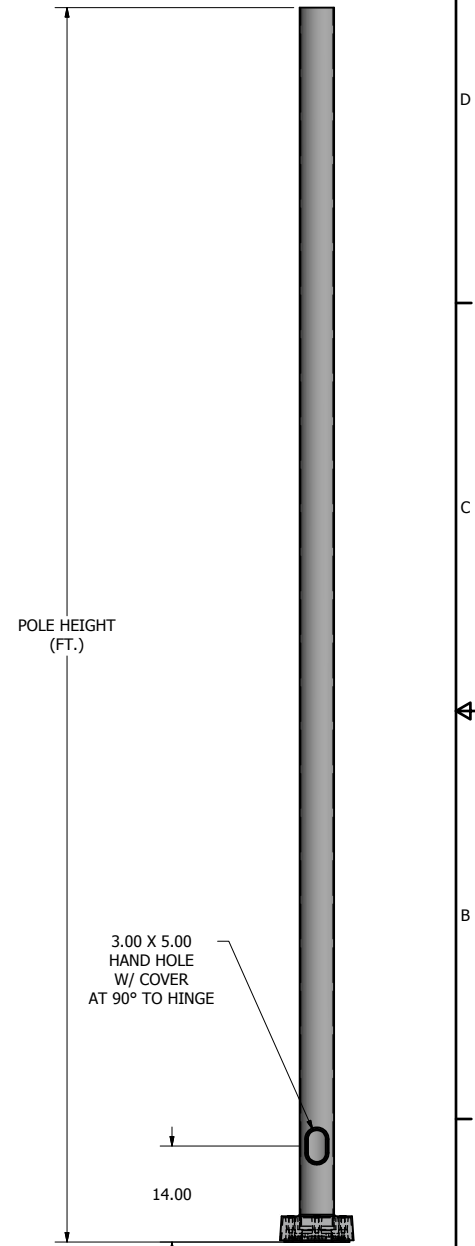

POLE DETAIL

lyte poles
 a DWM company
 P.O. Box 340
 Eastpointe, MI 48021
 P: (586) 771-4610 | F: (586) 771-5527
 www.lytepoles.com

| | |
|-------------------|-------------|
| DRAWN: M. HARVALA | 2/13/2015 |
| CHECKED: | |
| REVISION: | DATE: |
| APPROVED: | |
| QUOTE: | |
| S.O.# | |
| REF: | SCALE: NONE |

| | |
|---|--------|
| SOME GEOGRAPHICAL AREAS HAVE SPECIAL WIND CONDITIONS THAT CAN CREATE WIND INDUCED VIBRATIONS CAUSING A FATIGUE PROBLEM. NO METHOD HAS YET BEEN FOUND FOR PREDICTING DESTRUCTIVE LIGHTING POLE VIBRATION. THESE CONDITIONS ARE UNIQUE AND CANNOT BE GUARANTEED AGAINST, AND ARE THE RESPONSIBILITY OF A LOCAL SITE ENGINEER. | |
| TITLE: | |
| CATALOG: | |
| DWG NO: 605-5012-14 | SIZE C |
| SHEET 1 OF 1 | |

